



# ***DIMARINE***

**Experto**

**Fiable**

**Aventurero**

**Más de 40 años de experiencia en el rubro náutico**



***DIMARINE***

## MÁS DE 40 AÑOS ENTREGANDO CONFIANZA A LA INDUSTRIA ACUÍCOLA.



Dimarine es la división náutica de la compañía chilena de retail Dimarsa, una de las más antiguas del país, con más de 160 años de historia y tradición. Esta división nació con el objeto de brindar soluciones confiables y completas a la industria acuícola de Chile, así como desarrollar el mercado de la náutica deportiva y de turismo en el país.

Por más de 40 años, Dimarine se ha consolidado como fabricante de embarcaciones de polietileno de alta densidad (HDPE), fibra de vidrio (FRP) y aluminio naval, las cuales son ampliamente reconocidas en la industria por su calidad y resistencia. La gran experiencia que Dimarine posee en fabricación, le permite ofrecer soluciones integrales y a la medida de los requerimientos de sus clientes y que combinan la estética con la seguridad y confiabilidad que el mercado necesita.

Dimarine distribuye además, una completa gama de productos para la náutica de trabajo y deportiva, así como para el buceo profesional y comercial. Trabajando con marcas reconocidas internacionalmente como líderes en calidad como Yamaha Outboards, Highfield Boats, Hidea Outboards, Oxe Diesel, y Xpress Boats, entre muchas otras.

### INDICE

Introducción	3
Embarcación HDPE 9,3 MT cabina corta	4
Embarcación HDPE 6.0 MT	5
Embarcación HDPE 7.0 MT cabina corta	6
Embarcación HDPE 10.2 MT cabina larga	7
Embarcación HDPE 7.0 MT	8
Embarcación HDPE 8.5 MT	9
Embarcación HDPE 12 MT	10
Embarcación HDPE 5.8 MT	11
Embarcación HDPE 8.0 MT cabina Pilot	12
Embarcación HDPE 9.8 MT cabina corta	13
Embarcación HDPE 9.8 MT c/ Toldo	14
Embarcación HDPE 9.8 MT c/ Toldo	15
Lancha Aluminio 11.5 MT cabina larga	16
Lancha Aluminio 11.5 MT cabina larga	17
Lancha Aluminio 11 MT cabina larga	18
Botes de Aluminio Kimple	19
Motores Fuera de Borda	21
Botes Semirrígidos	23
Buceo	25
Industrial	27
Sostenibilidad	29

**TODAS NUESTRAS EMBARCACIONES DE HDPE SON FABRICADAS CON MATERIAL DE POLIETILENO DE ALTA DENSIDAD VIRGEN, LIBRE DE MANTENIMIENTO Y 100% RESISTENCIA A RAYOS UV, NO REQUIERE PINTURA; EMBARCACIÓN CON GRAN ESTABILIDAD E INHUNDIBLE.**



# EMBARCACIÓN HDPE 9.3M CON CABINA CORTA

powered by  **YAMAHA**



Embarcación de HDPE con cabina corta ubicada en la popa, con escalera en la proa y rampla de aluminio para ascenso/descenso de pasajeros.

Material	Rubro	Capacidad de pasajero	Eslora	Manga	Puntal	Motor
HDPE	Transporte de carga y pasajeros	7	9,3 mts	3,5 mts	1,65 mts	2 x 200 hp

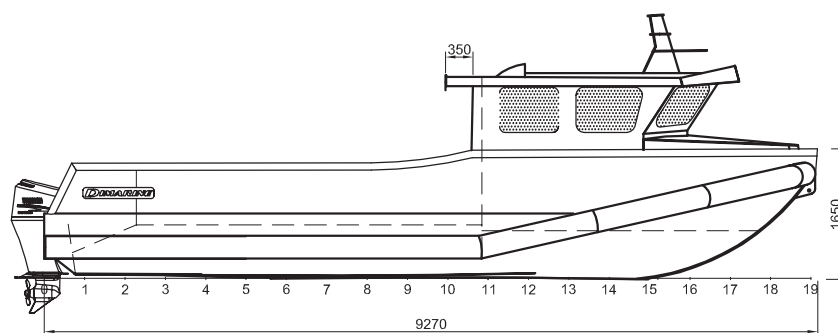

VISTA LONGITUDINAL

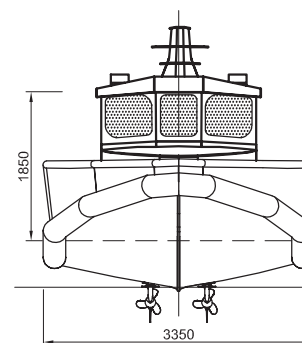

VISTA TRANSVERSAL (PROA)

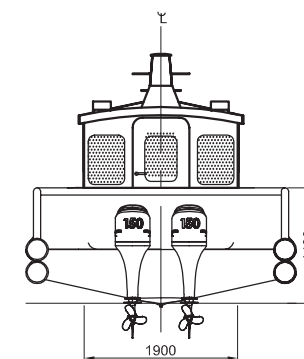

VISTA TRANSVERSAL (POPA)

**EMBARCACIÓN HDPE 6.0 MTS.  
MODELO ENDURANCE, SIN TUBOS**



powered by **YAMAHA**

Embarcación de HDPE abierta sin cabina, casco íntegramente construido de placas de HDPE sin tubos estructurales.

Material	Rubro	Capacidad de pasajero	Eslora	Manga	Puntal	Motor
HDPE	Transporte de carga y pasajeros	9	6 mts	2,3 mts	1,55 mts	2 × 50 hp

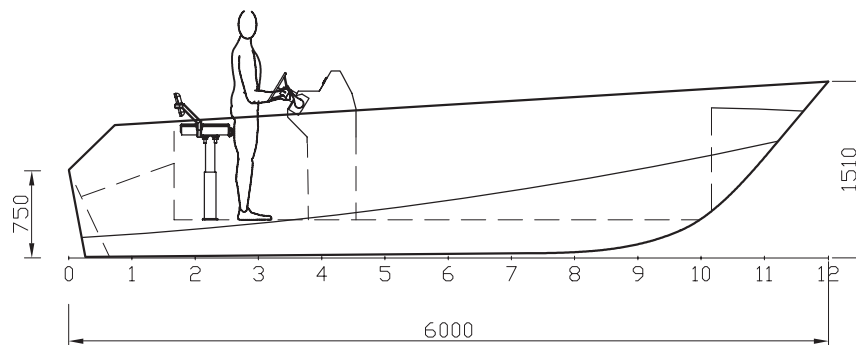

VISTA LONGITUDINAL

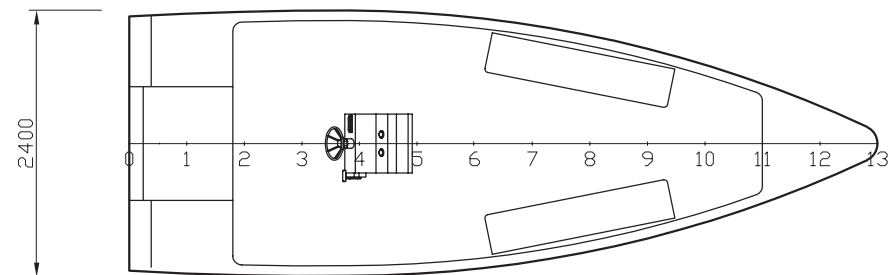

VISTA PLANTA

# EMBARCACIÓN HDPE 7.0 MTS. CON CABINA CORTA



powered by **YAMAHA**

Embarcación de HDPE con cabina corta ubicada en la popa, con escalera en la proa y rampla de aluminio para ascenso/descenso de pasajeros.

Material	Rubro	Capacidad de pasajero	Eslora	Manga	Puntual	Motor
HDPE	Transporte de carga y pasajeros	11	7,0 mts	2,32 mts	1,65 mts	100hp

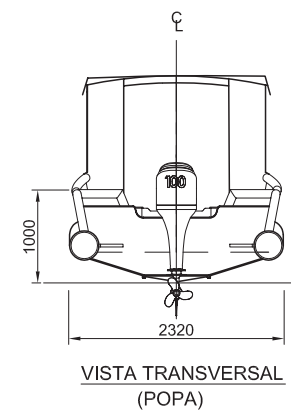
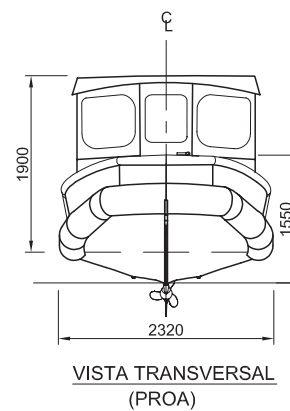
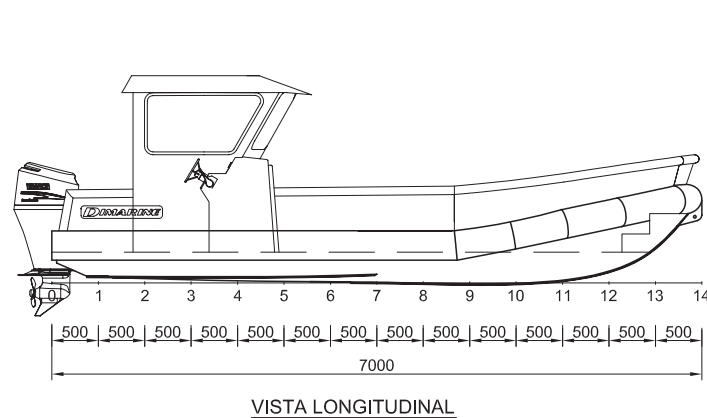

# EMBARCACIÓN HDPE 10.2MTS CON CABINA LARGA MODELO ENDURANCE

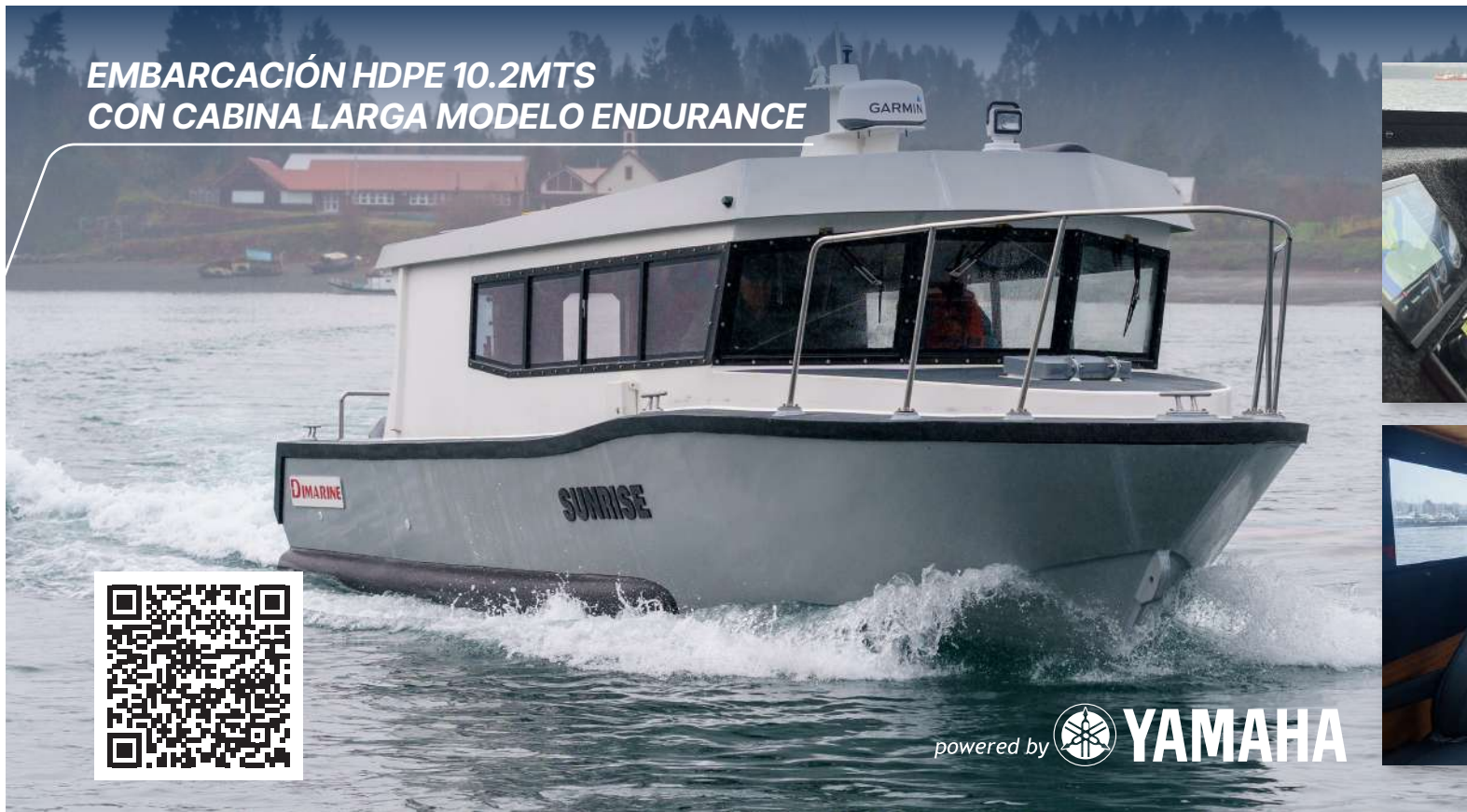

powered by  **YAMAHA**

Lancha de HDPE, equipada con butacas reclinables, techo interior de terciado marino y paredes alfombradas, piso de cubierta antideslizante, Butaca para capitán amortiguada, baño al interior de cabina.

Material	Rubro	Capacidad de pasajero	Eslora	Manga	Puntal	Motor
HDPE	Transporte de personas	12 personas 2 tripulantes	10,2 mts	3,31 mts	1,69 mts.r	2 x 200 hp V6

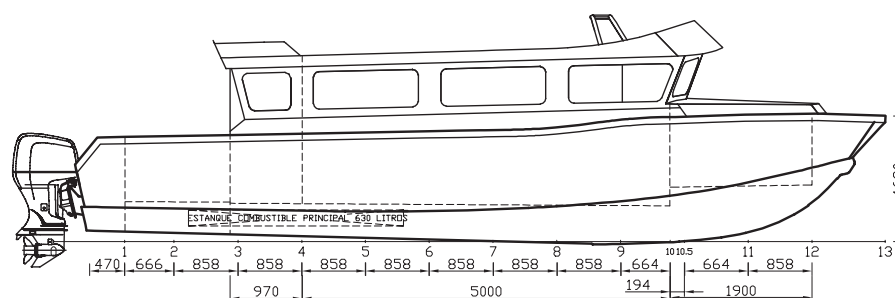

VISTA LONGITUDINAL

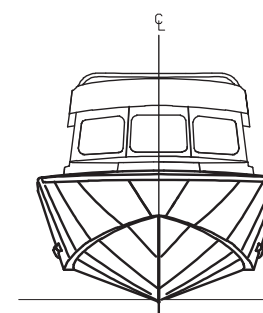

VISTA TRANSVERSAL  
(PROA)

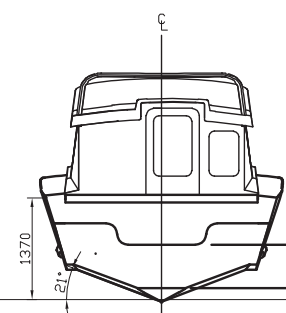

VISTA TRANSVERSAL  
(POPA)

# EMBARCACIÓN HDPE 7.0 MTS. MODELO PULUQUI



powered by  **YAMAHA**

Embarcación abierta, sin cabina, piso antideslizante, arco de luces, asientos laterales, opción de instalar consola, tubo de HDPE 28mm diámetro para mayor estabilidad

Material	Rubro	Capacidad de pasajero	Eslora	Manga	Puntal	Motor
HDPE	Pesca artesanal Transporte de personas	9	7,0 mts	2,38 mts	1,38 mts	115 hp

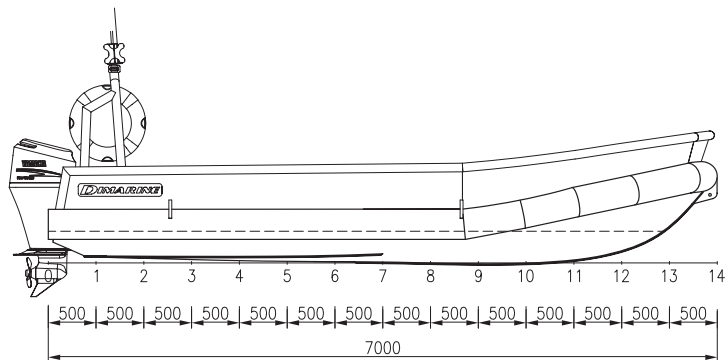

VISTA LONGITUDINAL

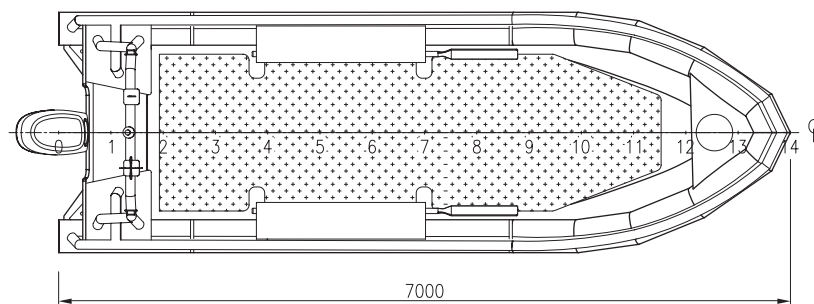

VISTA PLANTA



**EMBARCACIÓN HDPE 8.5 MTS.  
CON CABINA LARGA**



powered by  **YAMAHA**

Embarcación con cabina y asientos interiores laterales.

Material	Rubro	Capacidad de pasajero	Eslora	Manga	Puntal	Motor
HDPE	Transporte de personas	11	8,5 mts	2,32 mts	1,65 mts	2 x 50 hp

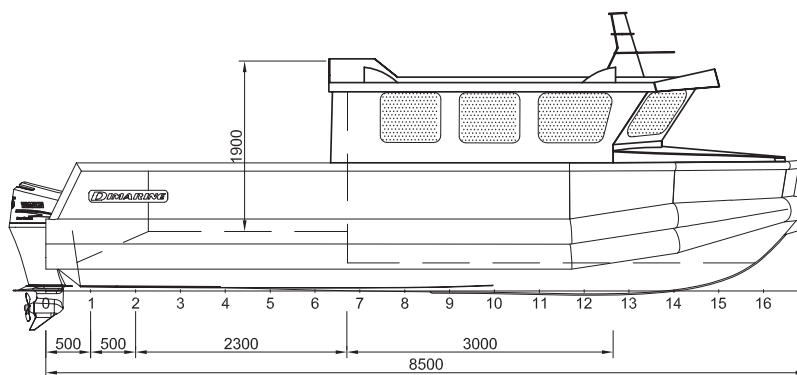

VISTA LONGITUDINAL

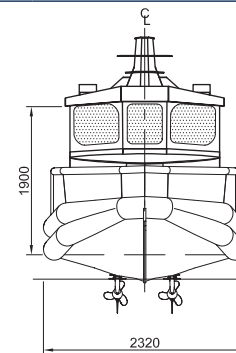

VISTA TRANSVERSAL (PROA)

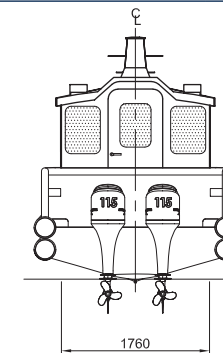

VISTA TRANSVERSAL (POPA)

# EMBARCACIÓN HDPE 12 MTS. CON CABINA EXTRA LARGA

powered by  **YAMAHA**



Embarcación con cabina, equipada con butacas reclinables, relleno de poliuretano no absorbente bajo cubierta, baño al interior de cabina.

Material	Rubro	Capacidad de pasajero	Eslora	Manga	Puntual	Motor
HDPE	Transporte de personas	26	11,8 mts	3,35 mts	1,75 mts	2 x 200 hp

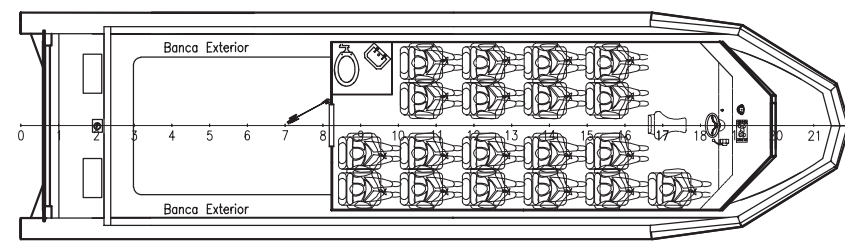
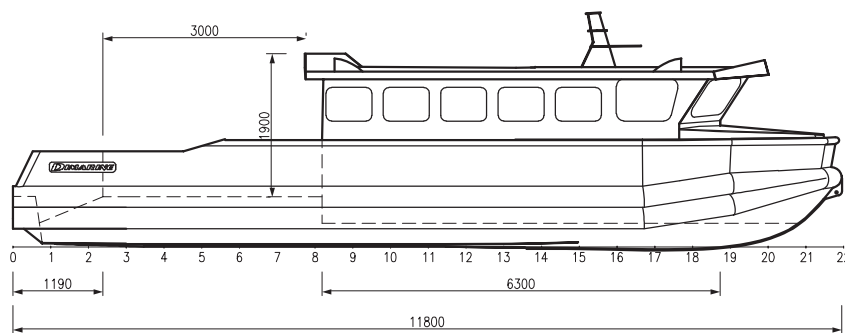

**EMBARCACIÓN HDPE 5.8 MTS.  
CON CABINA CORTA**

powered by **YAMAHA**



Embarcación con cabina y asientos laterales individuales.

Material	Rubro	Capacidad de pasajero	Eslora	Manga	Puntal	Motor
HDPE	Transporte de personas	5	5,80 mts	2,20 mts	1,30 mts	100 hp

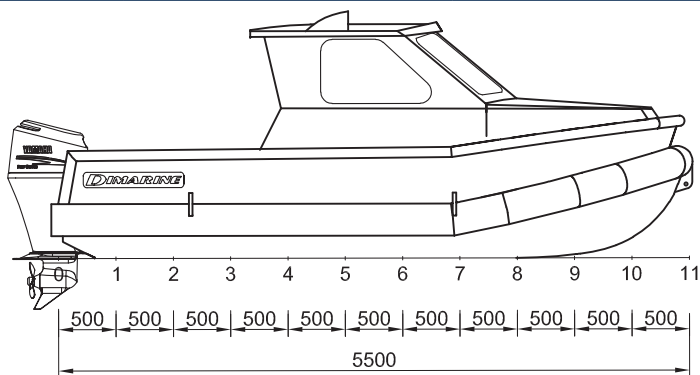

VISTA LONGITUDINAL

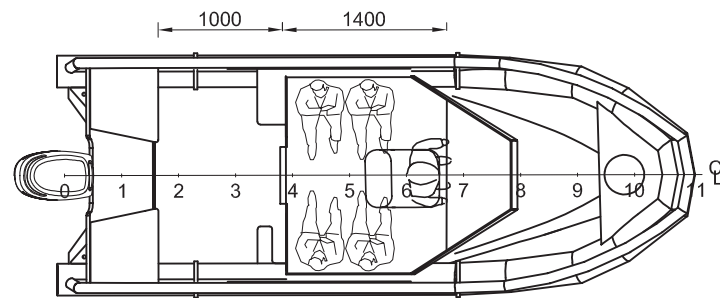

VISTA PLANTA

# EMBARCACIÓN HDPE 8.0 MTS. CON CABINA PILOT



powered by  **YAMAHA**

Embarcación con cabina Pilot, chofer y tripulante con ubicación en lo más alto de la cabina, relleno de poliuretano no absorbente bajo cubierta.

Material	Rubro	Capacidad de pasajero	Eslora	Manga	Puntual	Motor
HDPE	Transporte de personas	10	8 mts	3,20 mts	1,20 mts	200 hp

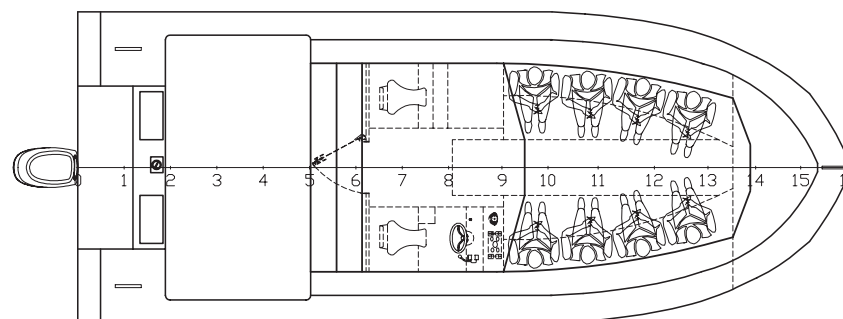
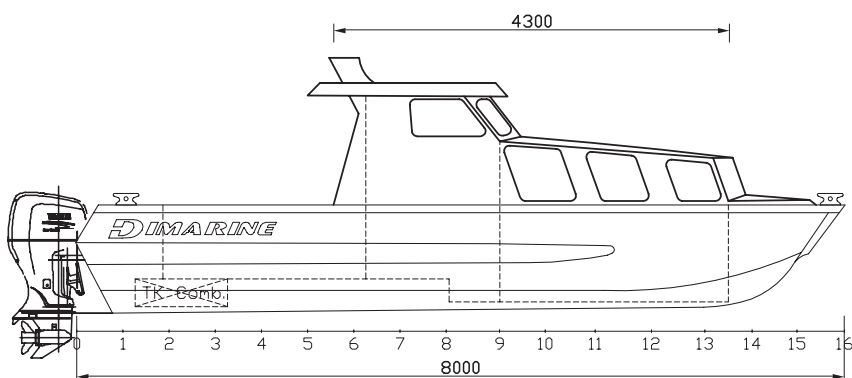

**EMBARCACIÓN HDPE 9.8 MTS.  
TURISMO CABINA CORTA 30P**

powered by **YAMAHA**



Embarcación con cabina pequeña para chofer, con butaca; equipada con asientos individuales para pasajeros.

Material	Rubro	Capacidad de pasajero	Eslora	Manga	Puntual	Motor
HDPE	Turismo	30	9,80 mts	2,60 mts	1,50 mts	100 hp

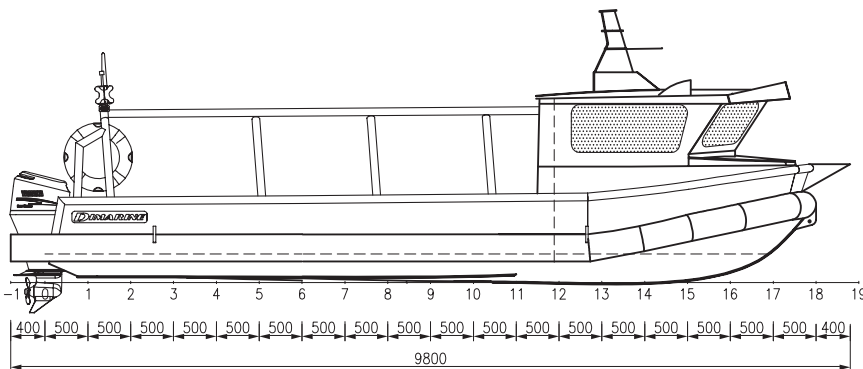

VISTA LONGITUDINAL

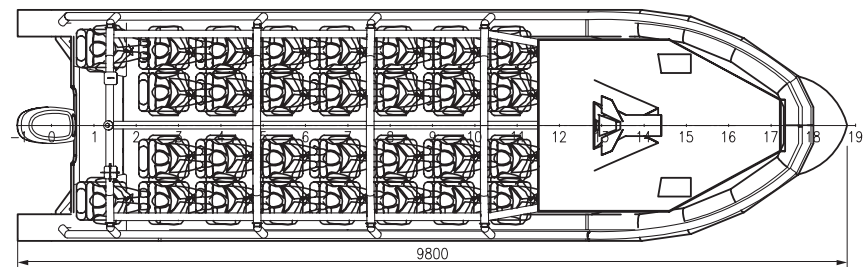

VISTA PLANTA

# EMBARCACIÓN HDPE 9.8 MTS. TURISMO CON TOLDO 30P

powered by  **YAMAHA**



Embarcación sin cabina, ideal para paseos y turismo, con asientos individuales y toldo para protección de los pasajeros, piso en cubierta antideslizante, pasamanos de acero inoxidable, escaleras en proa para descenso de pasajeros.

Material	Rubro	Capacidad de pasajero	Eslora	Manga	Puntual	Motor
HDPE	Turismo	30	9,80 mts	2,95 mts	1,45 mts	2 x 50 hp

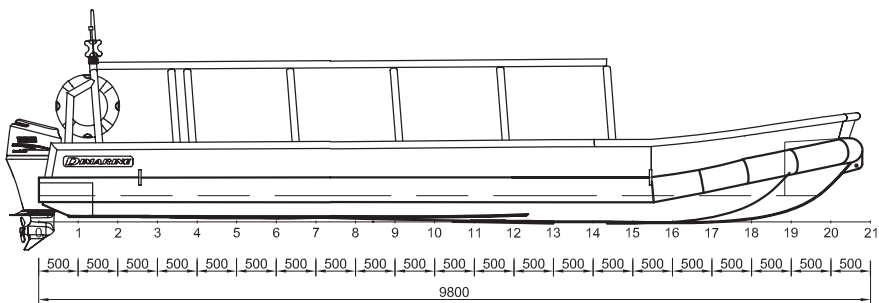

VISTA LONGITUDINAL

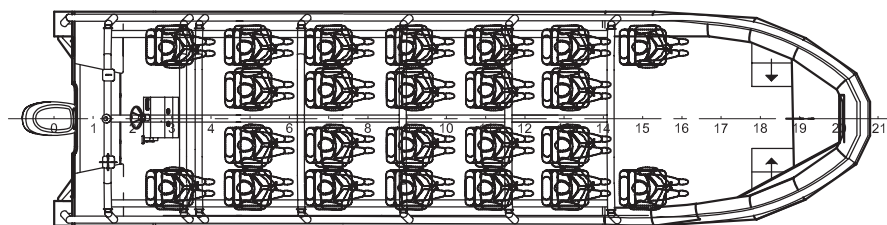

VISTA PLANTA

# EMBARCACIÓN HDPE 9.8 MTS. TURISMO CON TOLDO 36P

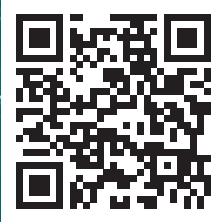

powered by  **YAMAHA**

Embarcación sin cabina, ideal para paseos y turismo, con asientos individuales y toldo para protección de lo pasajeros, piso en cubierta antideslizante, pasamanos de acero inoxidable, escaleras en proa para descenso de pasajeros.

Material	Rubro	Capacidad de pasajero	Eslora	Manga	Puntual	Motor
HDPE	Turismo	36	9,80 mts	2,95 mts	1,45 mts	50 hp

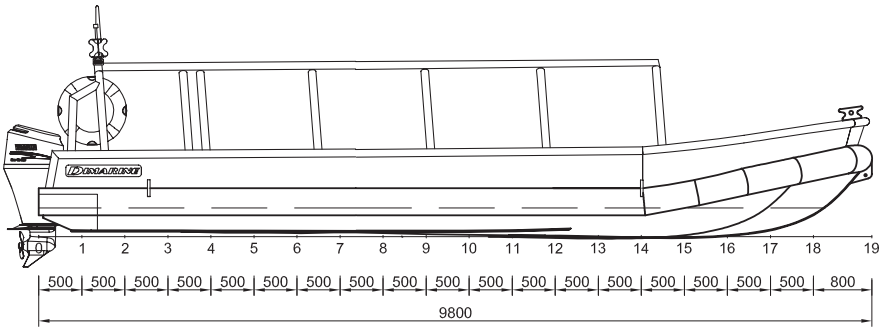

VISTA LONGITUDINAL

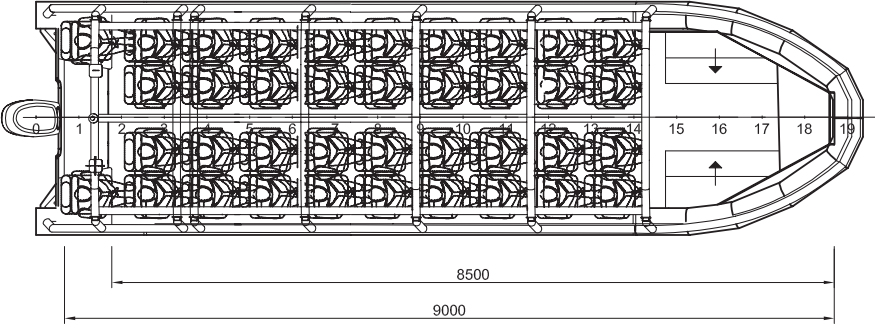

VISTA PLANTA

**LANCHA ALUMINIO 11.5 MTS.  
CABINA LARGA MOTOR IN-OUT**

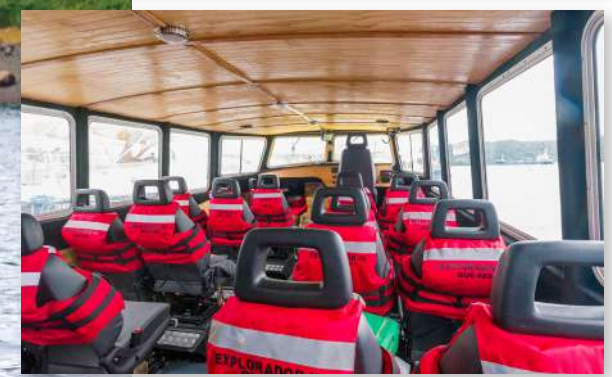
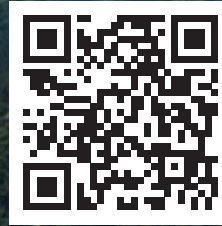

Lancha de aluminio, equipada con butacas reclinables, techo interior de terciado marino y paredes alfombradas, piso de cubierta con planchas de aluminio diamantadas y antideslizantes, butaca para capitán amortiguada, baño al interior de cabina.

Material	Rubro	Capacidad de pasajero	Eslora	Manga	Puntual	Motor
HDPE	Transporte de personas	24	11,5 mts	3,40 mts	2,10 mts	In-Out 200 hp

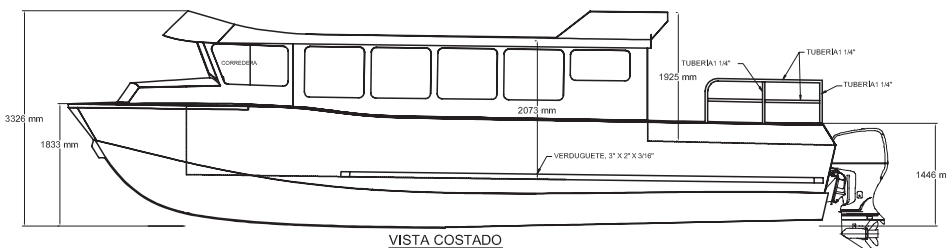

VISTA COSTADO

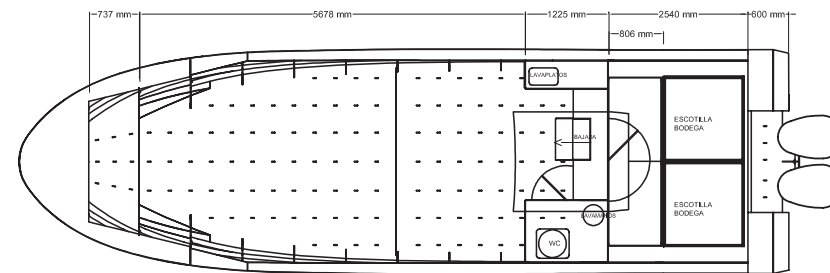

PLANO DE CUBIERTAS



# LANCHA ALUMINIO 11.5 MTS. CABINA LARGA MOTOR FB

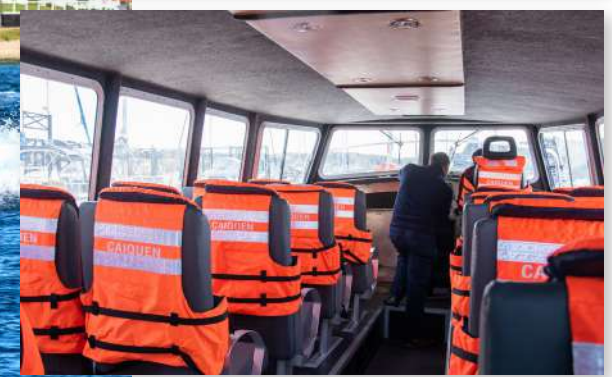

Lancha de aluminio, equipada con butacas reclinables, techo interior de terciado marino y paredes alfombradas, piso de cubierta con planchas de aluminio diamantadas y antideslizantes, butaca para capitán amortiguada, baño al interior de cabina.

Material	Rubro	Capacidad de pasajero	Eslora	Manga	Puntual	Motor
HDPE	Transporte de personas	24	11,5 mts	3,40 mts	2,10mts	2 x 300 hp

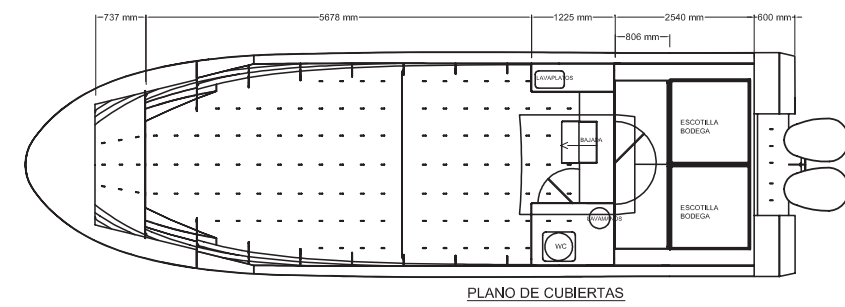
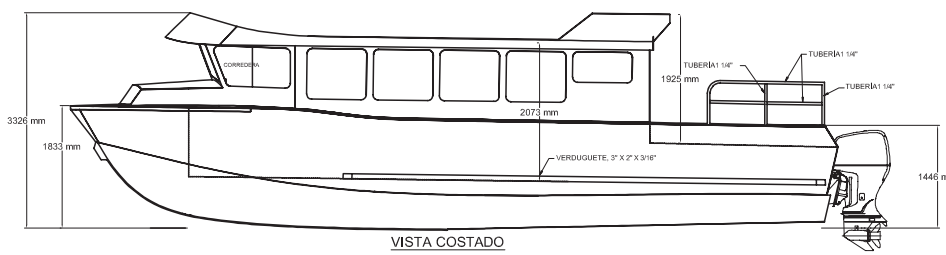

**LANCHA ALUMINIO 11 MTS.  
CABINA LARGA MOTOR FB**



Lancha de aluminio, equipada con butacas reclinables, techo interior de terciado marino y paredes alfombradas, piso de cubierta con planchas de aluminio diamantadas y antideslizantes, butaca para capitán amortiguada, baño al interior de cabina.

Material	Rubro	Capacidad de pasajero	Eslora	Manga	Puntual	Motor
HDPE	Transporte de personas	20	11 mts	3,24 mts	1,68 mts	2 x 300 hp

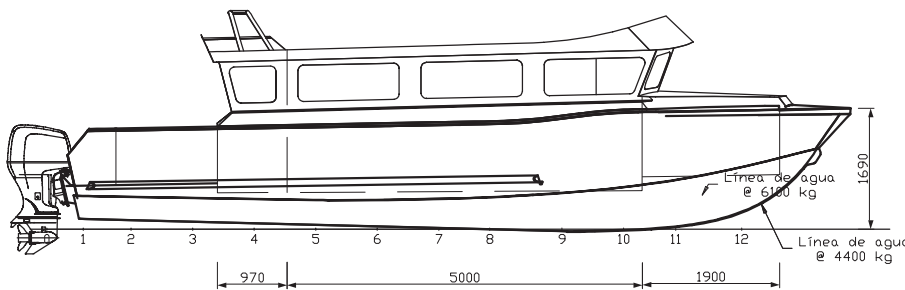

VISTA LONGITUDINAL

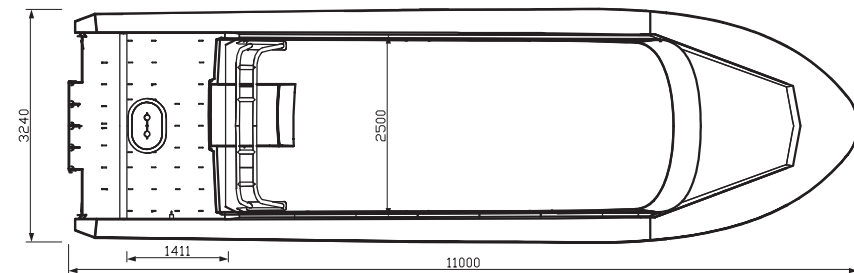

VISTA PLANTA



Bote de aluminio modelo CATCH, disponible en 3mts, 3.6mts y 4.0mts

Material	Modelo	Largo / Ancho	Potencia Motor	Capacidad de pasajero	Carga Máxima	Peso
Aluminio	CATCH 400	395x156 cm	20 HP Máxima	4	480 kg	89 kg



# MOTORES FUERA DE BORDA



 **YAMAHA**

Somos distribuidores oficiales de Yamaha en la zona sur de Chile. Con más de 30 años en la industria, abasteciendo al rubro acuícola con motores Yamaha y servicio técnico especializado.

2T



MOTOR F/B 40HP.  
E40XMHX

Código: 16090145

4T



MOTOR F/B 9,9HP PATA  
LARGA. FT9,9LMHL

Código: 502719

4T



MOTOR F/B 25 HP  
F25GMHL

Código: 1092226

4T



MOTOR F/B 50HP. FT-  
50CEHDL M/M

Código: 16090155

4T



MOTOR F/B 70HP  
F70AETL

Código: 358577

4T



MOTOR F/B 100HP.  
F100BETX

Código: 16090172

4T



MOTOR F/B 150HP  
F150FETX

Código: 641652

4T



MOTOR F/B 200HP  
F200FETX

Código: 561669

## BOTE SEMIRRÍGIDO - CASCO DE ALUMINIO



**HIGHFIELD**  
aluminum boats

Con alrededor de 54.000 embarcaciones entregadas en todo el mundo desde el inicio de la marca en 2011, Highfield Boats es ahora el número uno mundial en el sector de embarcaciones auxiliares semirrígidas y un actor global en el sector de más de 5 metros.

Código	Modelo	Largo / Ancho	Potencia Motor	Capacidad de pasajero	Carga Máxima	Peso	Material Tubo	Capacidad de Estanque
-	CLASSIC 400	396×197 cm	50 HP Máxima	8	878 kg	147 kg	PVC	- lts
-	SPORT 460	460×209 cm	70 CV Máxima	9	912 kg	332 kg	PVC	55 lts
-	SPORT 600	626×249 cm	150 CV Máxima	14	1580 kg	630 kg	PVC	140 lts

## BOTE SEMIRRÍGIDO CLASSIC 400



Incluye: Consola, Arco de luces, Asiento, Sundeck.

## BOTE SEMIRRÍGIDO SPORT 460



Incluye: Consola, Arco de luces, Piso Eva-Teak, Funda cubre bote, Asiento, Panel delantero, Escalera, Sundeck.

## BOTE SEMIRRÍGIDO SPORT 600



Incluye: Consola, Arco de luces, Piso Eva-Teak, Funda cubre bote, Asiento, Panel delantero, Escalera, Sundeck.

**BUCEO**







TRAJE WAVE MONO  
PIEZA 7MM HOMBRE  
AQUA LUNG  
Código: 1236838



TRAJE DE BUCEO  
DYNAFLEX 7MM HOMBRE  
AQUA LUNG  
Código: 1262323



GUANTE AQUA DIVE PRO  
WILD NEGRO CUERO  
Código: 1048309



BOTIN AQUADIVE PRO 6.5MM  
AQUADIVE  
Código: 1048293



REGULADOR SHERWOOD  
MAGNUS PRO SEGUNDO  
ESTADO NEGRO  
Código: 1296593



CONSOLA 3  
INSTRUMENTOS  
Código: 662845



COMPUTADOR  
DE BUCEO I200  
Código: 792358



CHALECO WAVE  
COMPENSADOR  
Código: 570648



ALETA EXPRESS  
Código: 405611



BOTELLA DE BUCEO  
ALUMINIO 11,1 LTS  
Código: 1032196



TRAJE WAVE C/  
GORRO 6MM MUJER  
AQUA LUNG  
Código: 1283249



TRAJE NEOPRENO  
10 - 13 MM  
AQUA DIVE  
Código: 497386



MÁSCARA LOOK 2  
WHITE CLEAR  
Código: 811207



MASCARA TEKNIKA  
NEW BLUE  
Código: 1179413



MASCARA BUCEO SHERWOOD  
VANTAGE MASK NEGRO  
Código: 1296589



CAMISETA 3MM SIN GORRO  
L/N COCIDA NEGRO  
Código: 1205683



COMPRESOR DE AIRE PARA BUCEO  
120 LTS HOOKAH AQUADIVE  
Código: 665740



COMPRESOR COLTRI MSH6 MINI  
COMP. 2.2KW 230 BAR/YOKE  
Código: 1175126



WINCHE PORTÁTIL 2000 KG  
C/ MOTOR GX 270 TORO 2.0  
Código: 936520

**INDUSTRIAL**



 **HONDA**



GENERADOR GASOLINA  
2,2 KVA P/M EU22

Código: 397616



GENERADOR EU 70 7KVA  
INSONORO

Código: 668015



ACEITE 10W30 HONDA  
ESTACIONARIO

Código: 368286



MOTOBOMBA WB 20XTDR 2"  
600LTS/MIN

Código: 16230102



MOTOBOMBA WB 30XTDR 3"  
1100LTS/MIN

Código: 11051



MOTOBOMBA WT-30XK3-D

Código: 177705



MOTOR GASOLINA 5,5HP P/M  
GX160QX

Código: 16011114



MOTOR GASOLINA 9HP P/M GX270QX

Código: 49588



MOTOR GASOLINA 13HP P/M GX390QX

Código: 38233



MOTOR GX 630

Código: 346982



MOTOR GX 690

Código: 346983

***DIMARINE***



## *Ser la empresa insignia en el **cuidado del medio ambiente** en el sur de Chile es uno de los principales objetivos de Dimarine*

- ✓ Brindamos soluciones pensadas para los medios acuáticos y adaptados a los requerimientos de cada cliente. Más de 40 años de experiencia y dedicación en el rubro náutico nos respaldan y nos permiten ser una alternativa fiable, con una comunicación abierta y transparente hacia nuestros clientes.
- ✓ Garantizamos calidad, protección y rendimiento en cada uno de nuestros productos.
- ✓ Nos comprometemos con el manejo responsable de nuestros residuos garantizando el manejo sustentable de envases, embalajes, aceites, lubricantes, neumáticos, baterías y otros residuos.
- ✓ Aplicamos rigurosamente la ley REP que regula los envases y embalajes declarada desde el 2021 al ministerio.



**Experto**



**Fiable**



**Aventurero**



***Dimarine, Pasión por el Agua***

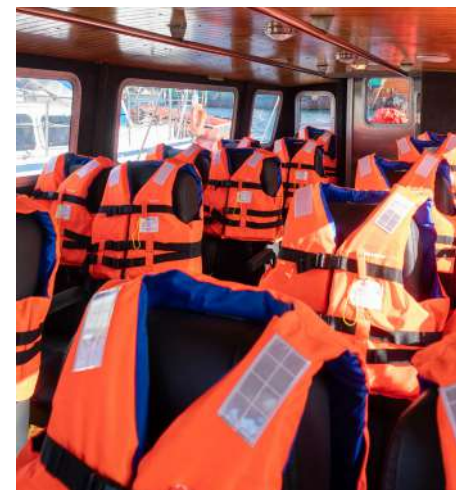



# ***DIMARINE***

**Av. El Tepual 3041, Puerto Montt, Chile**  
**Los Olivillos 268, Puerto Montt, Chile**  
**Ruta 5 Sur, Sector Ten-Ten, Castro, Chile**  
**Camino a Lago Riesco 110, Puerto Aysén, Chile**

 [dimarine.cl](http://dimarine.cl)

 [dimarinechile](https://www.facebook.com/dimarinechile)

 [dimarinechile](https://www.instagram.com/dimarinechile)

 [dimarine](https://www.linkedin.com/company/dimarine)

 [comercial@dimarine.cl](mailto:comercial@dimarine.cl)